

Front View

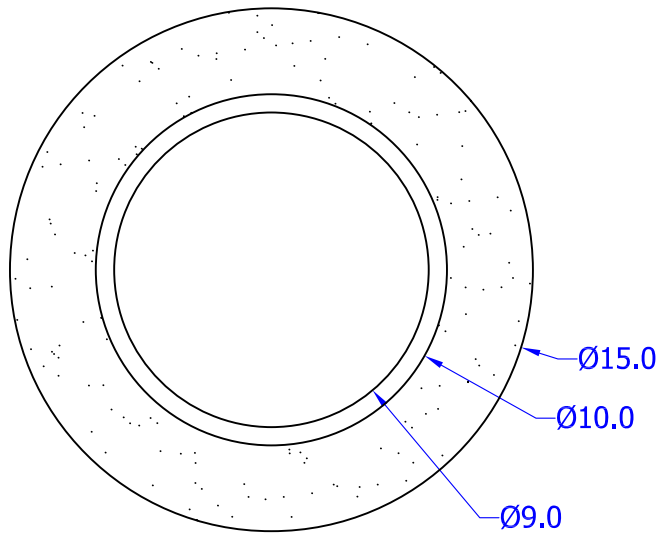

Top View

PROPRIETARY DATA

THIS DOCUMENT CONTAINS PROPRIETARY DATA OF QUALARC. NO DISCLOSURES, REPRODUCTION, OR USE OF ANY PART THEREOF MAY BE MADE EXCEPT BY WRITTEN PERMISSION OF QUALARC.

Qualarc, Inc.

11300 Trade Center Drive, #A 916-273-1576 phone
 Rancho Cordova, CA 95742 916-635-0228 Fax
 888-800-0153 toll free www.qualarc.com

NAME:

Trash Receptacle 14, inch size

DO NOT SCALE DRAWING

MATERIAL:

Fiberglass

FINISH

Slate textured

Tolerances: X, =±0.08inch
 . X=±0.06inch
 . XX=±0.04inch
 . XXX=±0.02inch

Qty:

Dimensions: Unless noted all dimensions are in **inch**

DRAWN BY

Jyg

DATE

11/28/08

DRAWING/PART#

0605-1 in

PAGE 1 of 1

CHECKED BY /DATE
 Xyn 11/28/08

APPROVED BY

REVISION BY /DATE
 Jyg 12/02/08

REV# ___

Angles: 1° or as otherwise noted